

Accessories: Mounting unit BES 30.0-BS-1

Common Data

Version
Usable with

Clamping cuff
clamping cuff for round Sensors
M30

Mechanical Data

Measurements WxHxD or Dia x D
Material
Mounting

55x38x18
PA6
with 2 screws M5

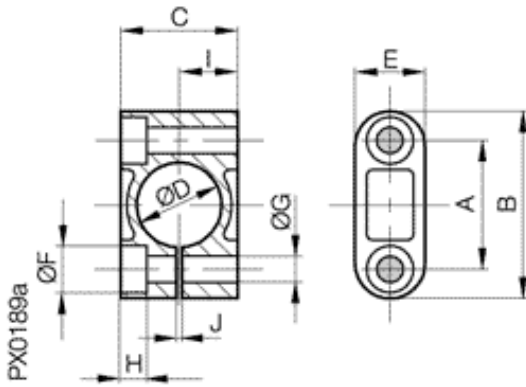

	A	B	C	D	E
BES 18,0-BS-1	26	36	26	17,9	12
BES 20,0-BS-1	32	45	30	20	15
BES 22,0-BS-1	32	45	30	21,9	15
BES 30,0-BS-1	42	55	38	30	18
BES 36,0-BS-1	48	61	44	35,9	18
	F	G	H	I	J
BES 18,0-BS-1	8	4,5	4,5	13	1
BES 20,0-BS-1	10	5,5	5,5	15	2
BES 22,0-BS-1	10	5,5	5,5	15	2
BES 30,0-BS-1	10	5,5	5,5	19	1,5
BES 36,0-BS-1	10	5,5	5,5	22	1,5

Datasheet number::

Definitions see general catalog.
If not otherwise noted, ratings according to
IEC 60947-5-2 (DIN EN60947-5-2)

Balluff GmbH
Schurwaldstrasse 9
73765 Neuhausen a.d.F.
Phone (07158) 173-0 Fax (07158) 5010

Datenblatt by CD-ROM - 04/2007

BALLUFF
sensors worldwide